

# User Manual

## AGRETO AgriCounter Vibration

5.3.2019



## Content

1	Introduction.....	3
2	Scope of delivery .....	3
3	Intended use.....	3
4	Security .....	3
4.1	Safety instructions for the buyer.....	3
4.2	Safety instructions for the operator .....	4
4.3	Personal protective equipment .....	4
4.4	Residual risks.....	4
5	Technical specifications .....	5
6	Configuration .....	5
6.1	Selection of the operating mode.....	5
6.2	Operating Keys .....	7
6.3	Setting the operating mode .....	7
6.4	Setting the parameters.....	7
6.5	Zeroing the counter.....	11
7	Assembly .....	11
7.1	Positioning of the meter .....	11
7.2	Fixing the mounting plate.....	12
7.3	Fastening of the meter .....	13
7.4	Attaching the seal .....	13
8	Working with the device.....	14
8.1	Reading the hours .....	14
8.2	Symbols on the display.....	14
9	Maintenance and cleaning .....	15
10	Troubleshooting.....	15
10.1	The battery symbol lights up .....	15
10.2	Operating hours are not counted completely .....	16
10.3	Too many operating hours are counted .....	16
10.4	The distinction between working time and transport time is not correct.....	16
10.5	Damage to the device .....	16
11	Warranty .....	17
12	Disposal.....	17
13	Imprint.....	18

# 1 Introduction

Thank you for choosing an AGRETO AgriCounter Vibration. You have acquired a robust tool for daily use.

Please read this manual carefully before using the equipment.

## 2 Scope of delivery

- 1 Display unit
- 1 Mounting plate
- 2 AAA batteries
- 5 Seals
- Mounting parts
- Manual

## 3 Intended use

The AGRETO AgriCounter Vibration is designed to measure operating hours on all types of machinery and equipment.

The activation takes place by movement / vibration of the machine. The device has different operating modes, depending on the setting and installation, a distinction can be made between working time and travel time.

## 4 Security

### 4.1 Safety instructions for the buyer



Important!

Make sure that every person who works for the first time with the AGRETO AgriCounter, has read and understood this manual.

## 4.2 Safety instructions for the operator



**DANGER!**

The AGRETO AgriCounter may only be operated by persons who are familiar with the operation of the device.



**CAUTION!**

Keep the work area clean! Soiled areas contributes to accidents.



**RISK!**

Risk of injury from tip-over / fall and inattention while working with the measuring instrument during getting on and off the tractor.

## 4.3 Personal protective equipment



**WARNING!**

For individuals who work with the device or reside in the working area the wearing of safety shoes are required.

## 4.4 Residual risks

When using the device residual hazards for persons and objects may occur that can't be prevented by design or technical protection measures.



**WARNING!**

The AGRETO AgriCounter must not be operated in explosive areas.

## 5 Technical specifications

- Packaging dimensions: 220x160x50 mm (LxWxH)
- Package weight: 450 g
- Device dimensions: 73 x 52 x 33 mm (WxHxD)
- Weight: 230 g
- Dust and waterproof plastic housing
- 3 internal control buttons for configuration
- Six-digit display with 11 mm digit height
- Icons for displaying additional information
- Powered by 2 x AAA batteries
- Battery life approx. 3 years

## 6 Configuration

### 6.1 Selection of the operating mode

The AGRETO AgriCounter Vibration has 4 operating modes, in which the hours are recorded in different ways. In some cases, the mounting location or the position of the meter is crucial.

First, decide which operating mode is suitable to your application, set the required settings if necessary, and then mount the counter on your machine!

#### Operating mode 1A – Total operating hours (standard)

In this operating mode, the AgriCounter reacts to all vibrations and movements of the machine, regardless of the position and location of the machine and the AgriCounter. The total time in which the machine is moving is summed up, regardless of whether it is used on the field, drive to the field or stationary operation.

The mounting location on the machine and the position of the counter are irrelevant in this operating mode. As position the angular position of the display is called, because of the readability, the counter is normally mounted in a horizontal position.

## AGRETO AgriCounter Vibration

### Mode 1B – Working hours only

In this mode, the AgriCounter reacts to vibrations and movements of the machine. However, the time is only summed up when the AgriCounter is in working position. The working position is the position of the counter in which it is located when the machine is in working position. The transport position is the position of the counter in which it is located when the machine is not in working position. The range for this transport position is defined with two adjustable angles.

In order to limit the collection of hours to the actual, productive working time, the meter must be mounted on the machine so that its position in the working position of the machine differs from its position in the transport position of the machine. This can be, for example, a side part, which is folded up during transport or on a chassis that is lifted up during use.

### Operating mode 1C – Working- and transport hours

This operating mode works identically to operating mode 1B, but it also adds up the time when the machine is moving and the counter is outside the defined position for the working position. With this mode the transport time or a time unproductive for the machine is detected and shown.

### Operating mode 1D - Working hours independent of movement

This mode is similar to Mode 1B, but it does not matter if the machine is moving or vibrating to summate the hours. The total time in which the counter is in working position is summed up, even at absolute standstill of the machine.

#### Overview:

Operating mode	Output	Activation by
1 A (default)	Hours	Vibration / movement
1 B	Hours in working position (= working time, productive time)	Vibration / movement + Location of the meter
1 C	Hours in working position (= working time, productive time) Hours outside working position (= travel time, unproductive time)	Vibration / movement + Location of the meter
1 D	Time in working position	Location of the meter regardless of movement

## 6.2 Operating Keys

The control buttons are located inside the device and accessible from the back with the mounting plate removed.

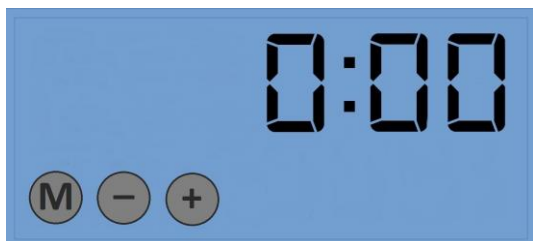

To change settings, look at the buttons and then turn the device with the display to the front to read the display.

Button	Definition	Function
M	Menu	Entry into the menu Continue to the next parameter, exit from the menu
-	Minus	Back to the previous step Decrease a parameter by 1
+	Plus	Continue to the next step Increase a parameter by 1

## 6.3 Setting the operating mode

On delivery, the operating mode 1A is preset.

To change the operating mode, press and hold the "M" button for 3 seconds. After releasing the key, the display briefly shows "MOdE" and then the current setting of the operating mode appears.

Change to the desired operating mode with the "+" or "-" buttons.

The "M" key (or if you wait 10 seconds) will save the selection and exit the menu.

**Please note: Changing the operating mode will reset all totals to 0.**

## 6.4 Setting the parameters

In order to customize the working method of the counter for the individual purpose, various parameters can be set. Preferences should be appropriate for most applications. Please change parameters carefully and only when needed. Not all parameters are available in each mode.

## **AGRETO AgriCounter Vibration**

---

To open the parameter menu, briefly press the "M" key. The first parameter that is relevant for the set operating mode appears on the display.

The name of the parameter is displayed for two seconds, then the set value appears.

Use the "+" or "-" keys to change the value of the parameter.

Use the "M" key to change to the next parameter, the set value is saved. After the last parameter, the first parameter is displayed again.

To exit the menu, press and hold the "M" button for three seconds, or simply wait 10 seconds without pressing a button.

### **Parameter SENS - Sensitivity (operating modes 1A, 1B, 1C)**

This parameter determines from which intensity of a movement the count is triggered, ie how strong the vibration or movement must be. The higher the value, the stronger the movement must be to trigger or continue the count.

0 = highest sensitivity (counts even on very small movements)

2 = a running internal combustion engine is already detected

4 = default

10 = lowest sensitivity (only counts for extreme movements)

The parameter SENS is related to the parameter hoLd, since a movement must always have a certain intensity and must be present for a certain period of time in order to trigger the summation.

### **Parameter hoLd – Holding time (mode 1A, 1B, 1C)**

In idle mode, this parameter determines the time in seconds that the counter waits after a first move to actually start the totalization permanently. If there is another movement within the set time (which is strong enough), the time from the first movement is added up and the counter is in counting mode. If there is no further movement within the set time, the counting is stopped and the sum is reset to the initial value.

1 = summation starts immediately after the first movement

20 = default

100 = summation is started after 100 seconds



## AGRETO AgriCounter Vibration

In counting mode, this parameter determines the length of a rest period in seconds, during which the count continues without interruption. If another movement follows within the set time (which is strong enough), the complete time is added up, including the rest phase. If the rest period lasts longer than the set time, the count stops and the sum is reset to the value at the beginning of the rest phase. The meter is now in idle mode.

1 = summation is stopped immediately at the end of the movement

20 = default

100 = A rest period of up to 100 seconds is counted

**Parameter A1 - Angle Start Transport Position (Mode 1B, 1C, 1D)**

**Parameter A2 - Angle End Transport Position (Mode 1B, 1C, 1D)**

These two parameters determine the beginning and the end of the position of the counter, which means the transport position for the machine. The angles are measured from the horizontal line starting from 0 in clockwise degrees, always seen from the front of the meter.

If the position of the counter is in the range within these two angles, the measured time is considered as transport time or unproductive time.

If the location of the counter is outside the range, the time is considered as working time or productive time.

In the default setting of the two angles, the transport situation starts at  $A1 = 45^\circ$  degrees and ends at  $A2 = 315^\circ$  degrees. The work situation starts at  $315^\circ$  degrees and ends again at  $45^\circ$  degrees.

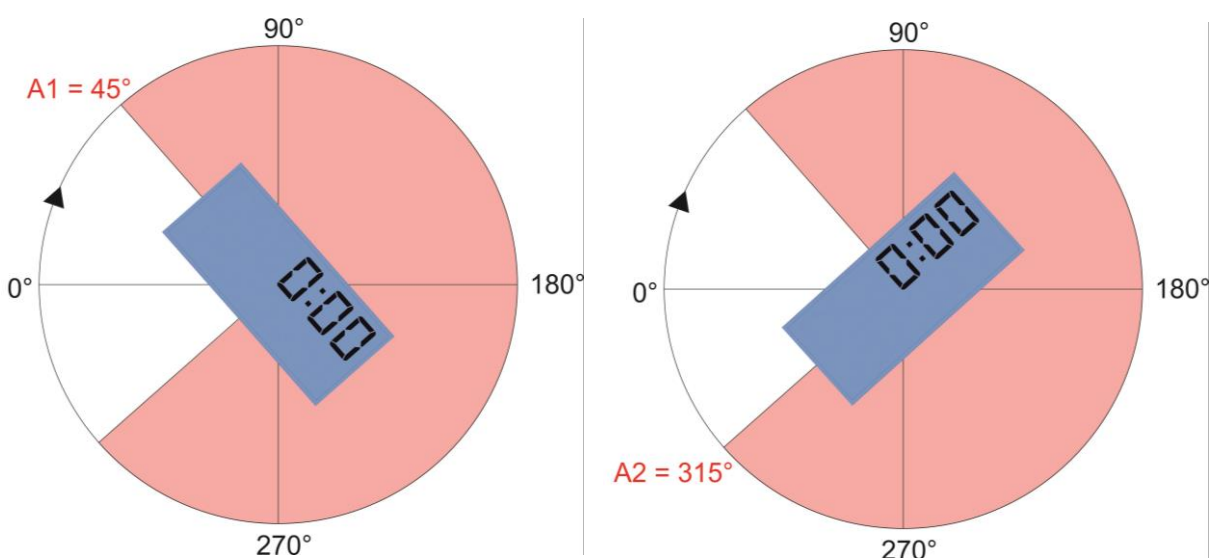

## AGRETO AgriCounter Vibration

The horizontal position of the counter and a turning of the counter up to 45 degrees in both directions is therefore rated as working position (= working position of the machine).

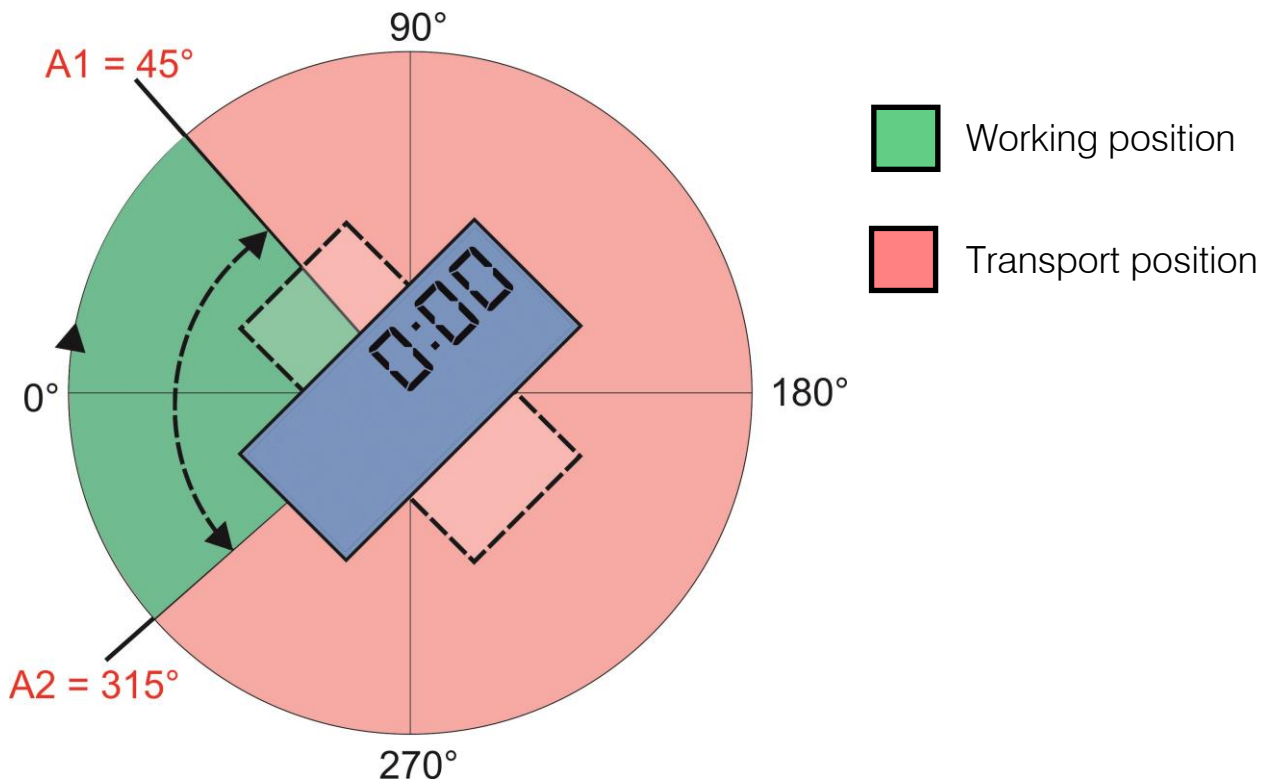

If the default setting does not suit for your application, you can either rotate the meter itself or change the angle settings in the parameters.

Make sure that the position of the meter, depending on the mounting position, may also change due to inclines and ascents, and calculate an appropriate tolerance.

You can already check the angle settings before finishing installation. When the meter is in working position, the symbol  $\text{°} \leftarrow$  is shown on the display. If the meter is in transport position, the symbol  $\text{°} \leftarrow$  is not shown on the display.

As long as the meter is not sealed, you can remove it at any time and change the angle settings. For optimization, place your machine on a horizontal surface.

## AGRETO AgriCounter Vibration

---

### Parameter Unlt - Display format (all modes)

This parameter determines the format of the hour display.

00:59 = default setting, display in hours and minutes (hhhh:mm)

00,99 = display in hours with 2 decimal places (hhhh,hh)

By default, the display is in hours and minutes, and the colon is used as the separator.

If necessary, you can change the display to decimal hours, here the comma is used as separator.

## 6.5 Zeroing the counter

To reset the counter, press and hold all 3 buttons together for 3 seconds. When released, all totals are set to 0.

# 7 Assembly

Only start with the assembly once you have clarified whether a change in the configuration is necessary for your application. Please read the chapter "Configuration" before.

## 7.1 Positioning of the meter

Choose the most protected, yet accessible mounting location on the machine.

The installation position is not relevant for operation of the counter in operating mode 1A.

In order to operate the device in operating modes 1B, 1C or 1D, ie to carry out a summation depending on the position of the meter, you must install the meter so that it is in a different position when the machine is in working position and when the machine is in transport.

## AGRETO AgriCounter Vibration

Mounting examples for position-dependent summation:

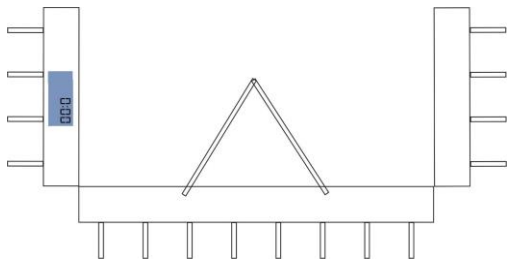

Transport position

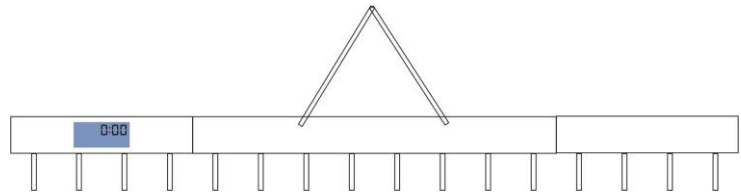

Working position

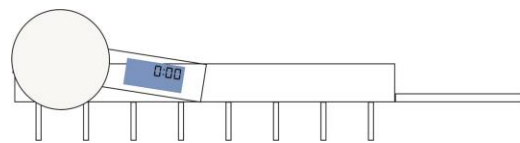
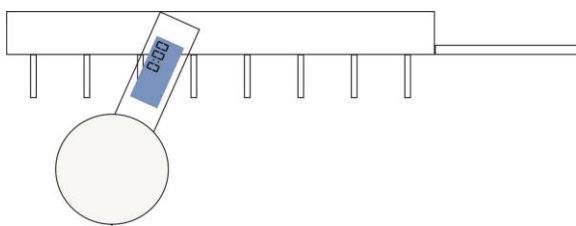

## 7.2 Fixing the mounting plate

- On delivery, the meter is mounted on the mounting plate. Disassemble the meter from the mounting plate.
- Hold the mounting plate in the desired position to the desired mounting position.
- Use the mounting plate as a template and mark the 2 holes with a pin.
- Hit one notch each with a grain.
- Drill the 2 holes with a 4.2 mm diameter drill.
- Deburr the 2 holes.
- Use a M5 screw tap to cut a thread in each hole.
- Use the 2 M5x25 allen screws and the 2 aluminum washers and screw the base plate to the machine. Note that the sealing surface of the base plate is pointing towards the meter.

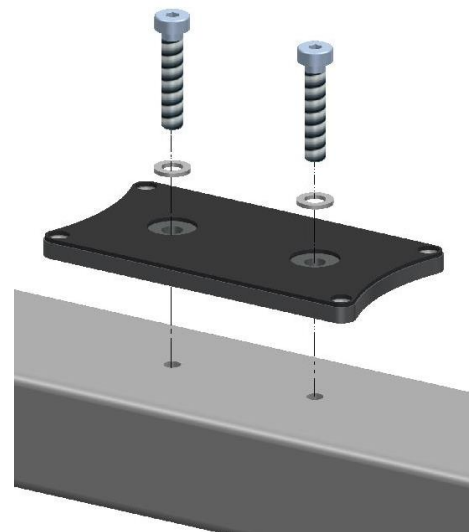

### 7.3 Fastening the counter

- Place the counter on the base plate.
- Use the 4 allen screws M5x8. Two of them have a small hole for the seal wire, use these two on the side where you want to attach the seal.
- First, pull slightly down all 4 screws, and then tighten every screw again so that the housing is evenly pressed against the mounting plate.

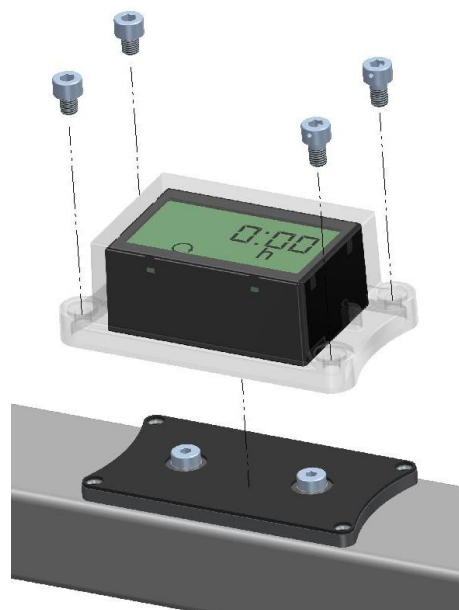

### 7.4 Attaching the seal

- Thread the seal wire through the holes in the two screws.
- Thread both ends of the wire through a hole in the seal.
- Slide the seal as close as possible to the meter and at the same time tighten the wire.
- Close the seal.

If the hole of one of the screws is not accessible, you can also drill a small hole in the housing bar between the two screws and pull through the seal wire here.

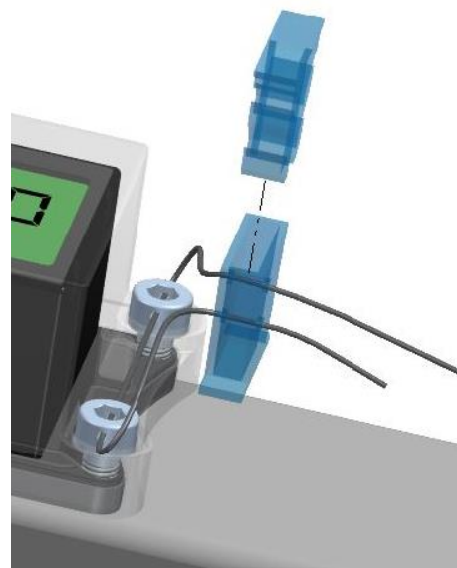

## 8 Working with the device

### 8.1 Reading the hours

The AgriCounter Vibration permanently displays the sum of the counted hours, an operation is not provided for reading.



If the colon is visible as a separator, it is hours and minutes.

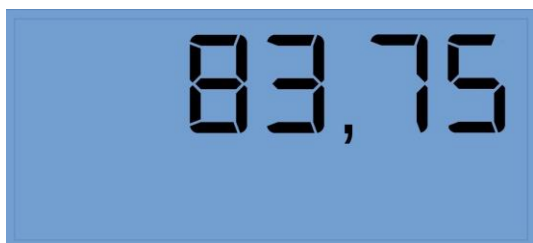

If the comma is visible as a delimiter, it is decimal with 2 decimal places.

The display is updated every 5 seconds.

In operating mode 1C, the display of the hours changes every 5 seconds between the sum of the working time and the sum of the transport time.

### 8.2 Symbols on the display



Below the hour display there are various icons for displaying additional information.

 The down arrow means that the currently displayed hours refers to the working time (device down = working position).

 The up arrow means that the currently displayed hours refers to the transport time (device up = transport position).

 The wavy line means that the counter is currently detecting movement or vibration and is in counting mode.

## AGRETO AgriCounter Vibration

---

**h** The h means that the displayed values are hours.

**S** The s lights up in the setting mode when a parameter value is expected in seconds.

 The crossed-out battery icon lights when the batteries are low and you need to replace them.

 The angle symbol illuminates when the meter is in working position. In setting mode, it also lights when a parameter value in degrees is expected.

## 9 Maintenance and cleaning

The AgriCounter basically does not require ongoing maintenance.

- If the display is dirty, clean it for reading.
- If the battery symbol is lit, replace the batteries.

## 10 Troubleshooting

### 10.1 The battery symbol lights up

The batteries need to be replaced, follow these steps:

- Remove the seal and the seal wire.
- Remove the housing and remove the meter.
- Remove the old batteries and dispose them properly.
- Insert 2 new AAA batteries into the device in the specified direction.
- Mount the counter again on the mounting plate.
- Seal the device again with a new seal wire and a new seal.

## 10.2 Operating hours are not counted completely

The movements or vibrations on the machine are probably relatively low, so that the necessary intensity for the count is not reached.

- Set the parameter SENS down so that the counter triggers even with minor movements.
- To hold longer periods of rest during operation, set the parameter hOLd upwards.

## 10.3 Too many operating hours are counted

Perhaps the machine is exposed to light movements at standstill, which are recorded as operating hours.

- Set the parameter SENS upwards so that the counter only triggers for larger movements
- To prevent idle phases from being counted during operation, set the hOLd parameter down.

## 10.4 The distinction between working time and transport time is not correct

- First make sure that the sum of the two times matches the actual total hours worked (working time and transport time). If this is not the case, proceed as described in the previous points.
- Check the setting of the two angles **A1** and **A2**.
- If the meter is in working position, the symbol  $\angle$  on the display must light up permanently. If this is not the case, move the area for the transport position by changing the relevant angle.
- When the meter is in transport position, the symbol  $\angle$  on the display must not light up. If this is the case, move the transport position range by changing the angle.
- If the difference in angle between working position and transport position is too small for a correct distinction, you must find another mounting location on the machine.

## 10.5 Damage to the device

- Contact the manufacturer or your dealer



## 11 Warranty

Over and above statutory warranty for AGRETO AgriCounter Vibration following warranty provisions apply :

- The AGRETO electronics GmbH guarantees the function and repairs or replaces all the parts that have a material or manufacturing damage within the warranty period.
- Warranty services will be performed by the AGRETO electronics GmbH.
- The decision on the existence of a warranty claim is sole responsibility of the AGRETO electronics GmbH.
- The warranty period begins with the first accounting to an end customer and ends 5 years from this date of invoice.
- Prerequisite for warranty service are the presentation of the original invoice and compliance with all elements of this instruction manual.
- Excluded from warranty are wear, normal wear and tear, damage due to misuse, negligence or accident.
- When processing a warranty claim transport costs incurred will be charged to the buyer.

## 12 Disposal



Dispose of the device as part of the final shutdown or parts of it environmentally friendly and sorted (metal to the respective metal scrap, plastic to the plastic waste, etc. - do not dispose as household waste)!

Detailed information can be found in directive 2002/96 / EC

## 13 Imprint

All information, specifications and illustrations are as of 2019, subject to technical changes or design changes.

All information in this manual are supplied without liability despite careful preparation. A liability by the author is excluded.

Copyright © 2019, AGRETO electronics GmbH

AGRETO electronics GmbH  
Pommersdorf 11  
A-3820 Raabs

Tel.: +43 2846 620  
Fax: +43 2846 620 19  
E-Mail: [office@agreto.com](mailto:office@agreto.com)  
Internet: [www.agreto.com](http://www.agreto.com)